

CHAPTER 2 STATICS

2-1

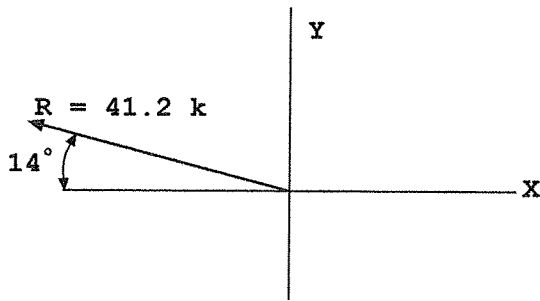
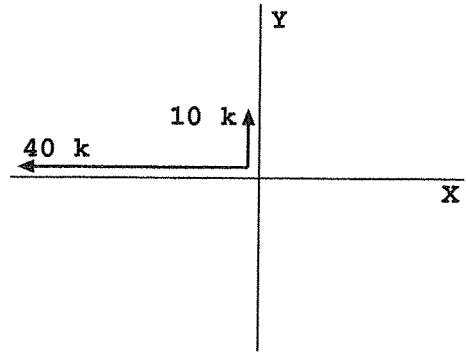
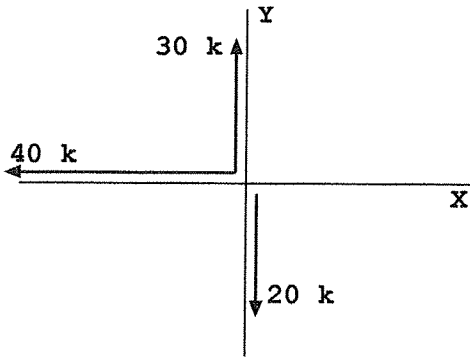

$$\tan \theta = \frac{10}{40}$$

$$\theta = 14^\circ$$

2-1M

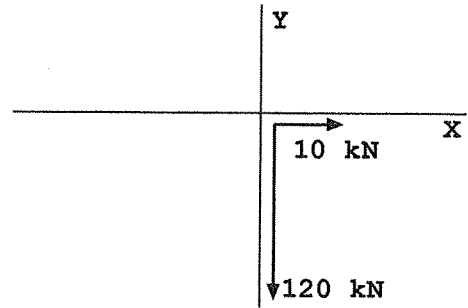
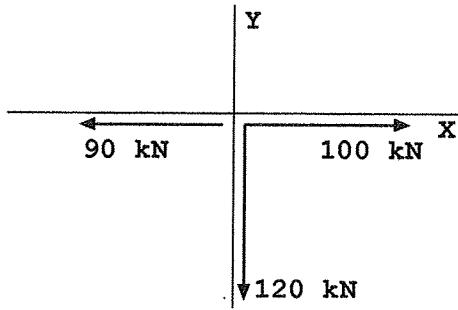

$$\tan \theta = \frac{120}{10}$$

$$\theta = 85.2^\circ$$

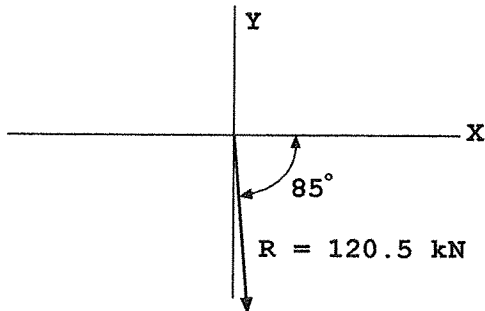

2-2

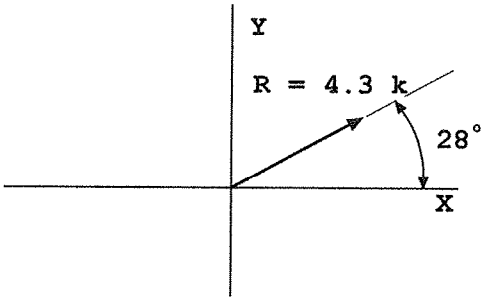
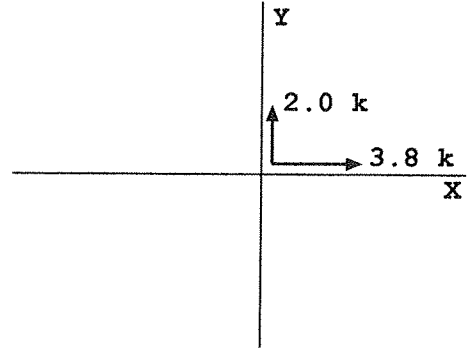
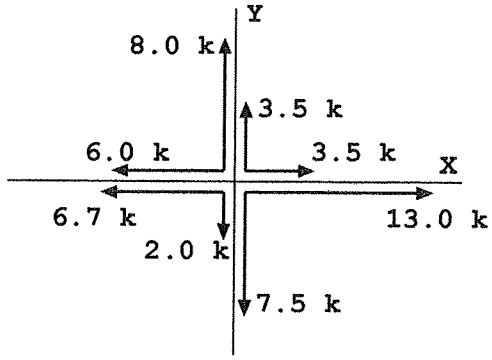

$$\tan \theta = \frac{2.0}{3.8}$$
$$\theta = 27.8^\circ$$

2-2M

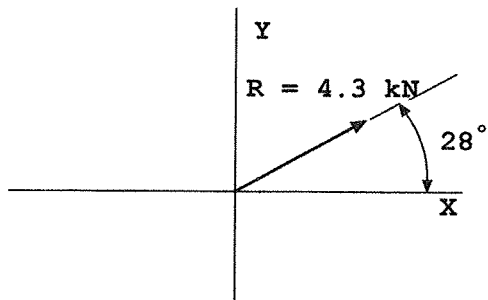
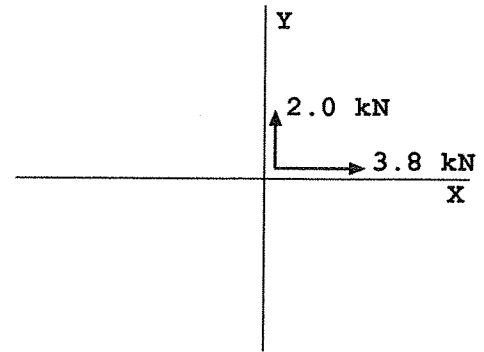
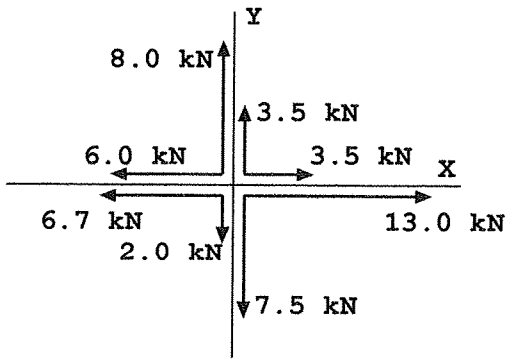

$$\tan \theta = \frac{2.0}{3.8}$$
$$\theta = 27.8^\circ$$

2-3

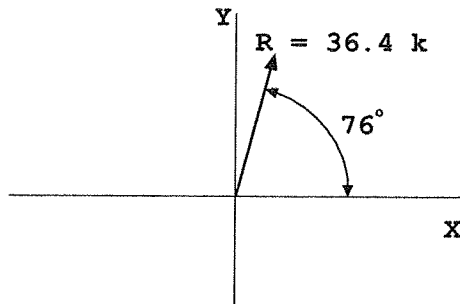
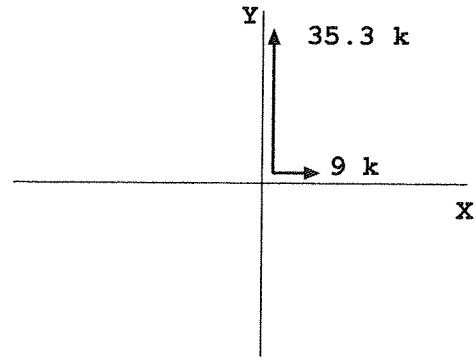
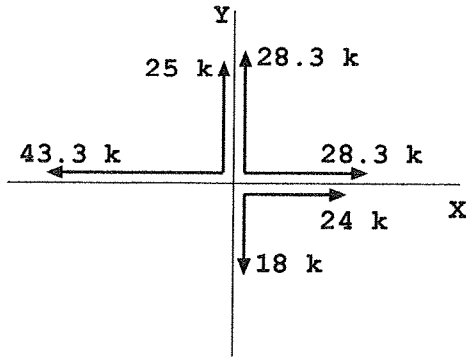

$$\tan \theta = \frac{35.3}{9}$$
$$\theta = 75.7^\circ$$

2-3M

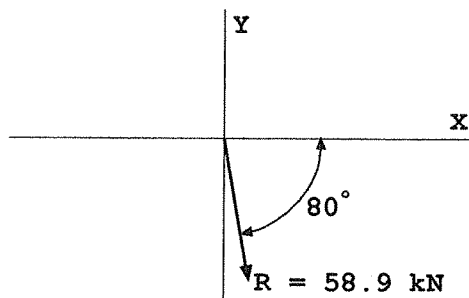
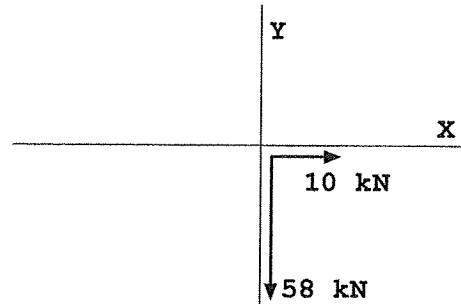
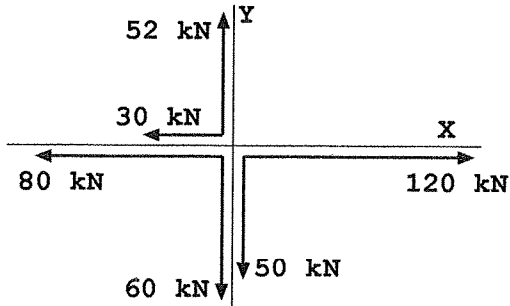

$$\tan \theta = \frac{58}{10}$$
$$\theta = 80.2^\circ$$